

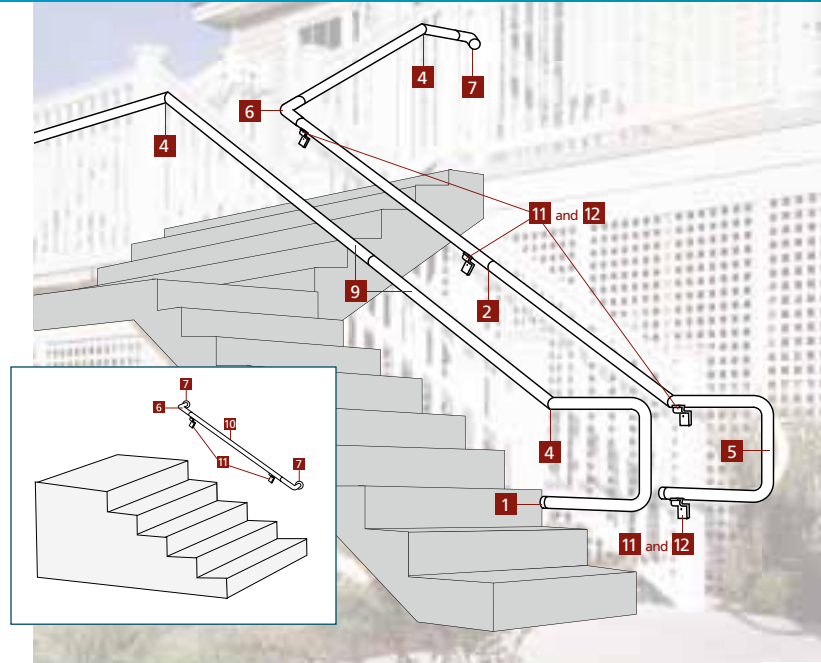

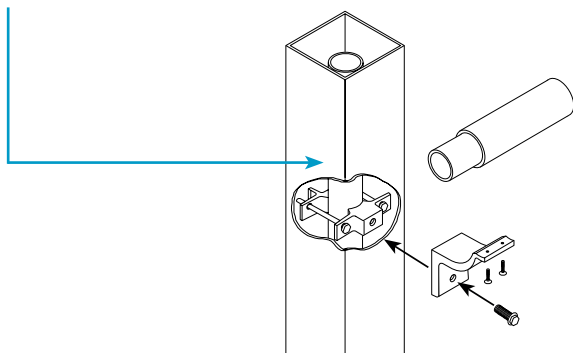









# { vinyl railing collection accessories ... }

*Meet local code with EverNew vinyl hand rail component systems.*

- Complies with ADA (Americans with Disabilities Act) requirements for grippable hand rails
- 1-1/2" diameter gripping area
- Continuous hand rail runs
- Safe for stair and ramp applications
- Aluminum reinforced construction reduces bowing, provides enduring strength, and allows for easy installation
- Functional finishing touches: post and wall returns, end caps, return loops and a convenient straight joiner
- Unique adjustable internal aluminum joiner accommodates any transition – 0° to 90° bends
- Installs easily on site with no preformed fittings
- Ideal for use with all EverNew railing systems
- Virtually maintenance free
- Lifetime limited warranty
- EZ Set bracket kit available for attachment to routed system



-  **1** 1-1/2" diameter vinyl end cap
-  **2** Straight aluminum joiner
-  **3** Straight wall return (includes vinyl trim)
-  **4** Adjustable aluminum internal joiner
-  **5** 1-1/2" OD ADA 180° return loop
-  **6** 1-1/2" OD - 90° corner - includes two 3" aluminum joiners
-  **7** 1-1/2" OD - 90° wall return - includes 3" aluminum joiner
-  **8** 1-1/2" OD x 80" vinyl hand rail with aluminum insert
-  **9** 1-1/2" OD x 104" vinyl hand rail with aluminum insert
-  **10** 1-1/2" OD x 120" vinyl hand rail with aluminum insert
-  **11** Hand rail bracket assembly
-  **12** Hand rail EZ Post attach kit

*Note: Hand rail depicted is not free standing and must be anchored to walls or guardrail using hand rail bracket assembly (E74028/E74029). Space a maximum of 6' on center and as close as possible to both sides of any joint. (ADA compliant at 6ft. spans)*